



MODEL T

MOTUS

KOOI

SLING

KATE

FLOW

POISE

DALA

JER

BOLHA

TYLA

FLOED

NAMI

VICEVERSA

GIASS

EVITA

E.T.A.

SHAKTI

TATU

LANNÀ

HIVE

LILLI

OPYO

DEW

MINIMAL

YUMA

KUSHI

KYUDO

AZOU

# MODEL T

FRANCESCA SMIRAGLIA/ 2023

MODEL T . MOTUS . KOOI . SLING . KATE . FLOW . MITOS . POISE . DALA . JER . BOLHA . TYLA . FLOED . NAMI . VICEVERSA . GIASS . EVITA . E.T.A . SHAKTI . TATU . LANNÀ . HIVE . LILLI . OPYO . DEW . MINIMAL . YUMA . KUSHI . KYUDO . AZOU

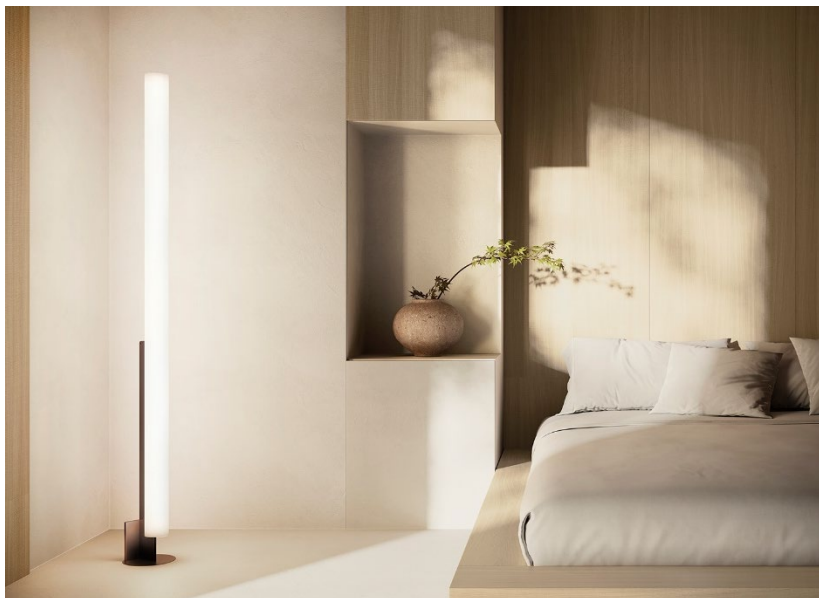

The De Stijl artistic movement inspires with its linear and simple forms. And precisely, the two-dimensional geometric shapes such as the square and the rectangle act as a counterweight to the tubular and three dimensional light of Model T, the minimalist, sculptural and universal floor lamp.

Dimmable floor lamp. Tubular diffuser made of opal methacrylate. Metallic coated structure.

LIST PRICE:

BLACK: \$ 2.290

POP: \$ 2.290

INOX: \$ 2.990

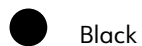

Black



Pop



Inox

## MODEL T

ø 23 x L 10 x H 185 cm

board LED 1x60W  
2700 K - 6600 lm - CRI > 90

100 -240 V

Dimmerabile

CLASS 2 - IP20 - CE

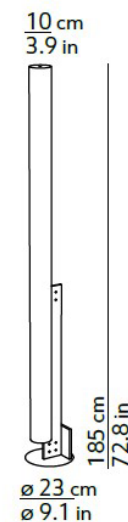

# MOTUS

## SHULAB / 2023

MODEL T . MOTUS . KOOI . SLING . KATE . FLOW . MITOS . POISE . DALA . JER . BOLHA . TYLA . FLOED . NAMI . VICEVERSA . GIASS . EVITA . E.T.A . SHAKTI . TATU . LANNÀ . HIVE . LILLI . OPYO . DEW . MINIMAL . YUMA . KUSHI . KYUDO . AZOU



### MOTUS

board LED 1x22W  
2700 K - 2420 lm - CRI>90

220-240 / 120 V

Dimmerabile taglio di fase

CLASS 1 - IP20 - CE

**Unconditional freedom and ability to adapt to a stimulating environment and changing needs. This is the common denominator between Motus and a skill sport such as vertical wall climbing. Press and Release. A single interaction, a simple movement. Motus slides along its power cord, adjusting to different heights and supporting itself thanks to its own weight.**

Suspension lamp with adjustable height. Opal glass diffuser. Metallic structure available in three coating finishes.

- White
- Black
- Red

LIST PRICE :  
\$ 990

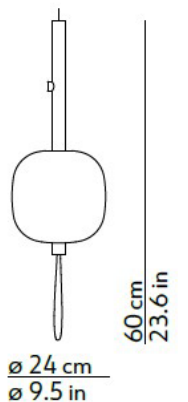
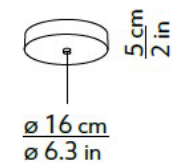

# KOOI

STUDIO SHUU / 2023

MODEL T . MOTUS . KOOI . SLING . KATE . FLOW . MITOS . POISE . DALA . JER . BOLHA . TYLA . FLOED . NAMI . VICEVERSA . GIASS . EVITA . E.T.A . SHAKTI . TATU . LANNÀ . HIVE . LILLI . OPYO . DEW . MINIMAL . YUMA . KUSHI . KYUDO . AZOU



Kooi is inspired by Chinese Shan shui painting and conveys its philosophy. Thanks to the contrast between the glass diffuser and the metal frame, lights and shadows become the protagonists of continuous visual effects and unprecedented changes of perspective. Glass and metal. Light and heavy. Black and white. The Shan shui spirit becomes a suspension lamp.

Suspension lamp. Transparent glass diffuser and die-casted aluminium structure.

LIST PRICE :  
\$ 1.490

● Black

**KOOI**  
board LED 1x25W  
2700 K - 2750 lm - CRI>90

220-240 / 120 V

Dimmerabile taglio di fase

CLASS 1 - IP20 - CE

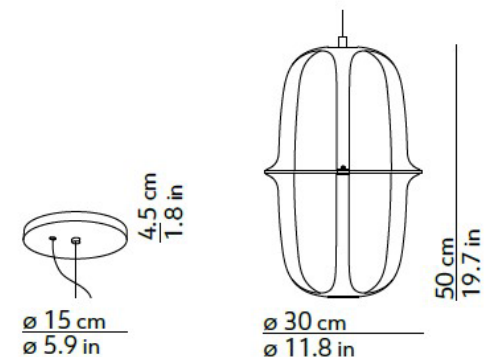

# SLING

CHRIS BASIAS / 2023

MODEL T . MOTUS . KOOI . SLING . KATE . FLOW . MITOS . POISE . DALA . JER . BOLHA . TYLA . FLOED . NAMI . VICEVERSA . GIASS . EVITA . E.T.A . SHAKTI . TATU . LANNÀ . HIVE . LILLI . OPYO . DEW . MINIMAL . YUMA . KUSHI . KYUDO . AZOU

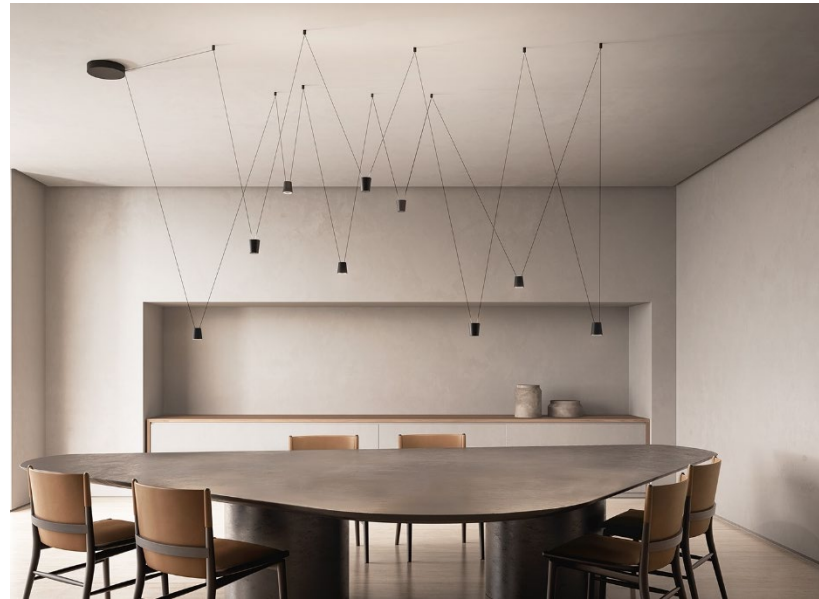

## SLING

board LED 1x6W  
3000 K - 660 lm - CRI>90

220-240 / 120 V

Dimmerabile 1-10 V

CLASS 3 - IP20 - CE

**A single unipolar cable transfers current and supports multiple light sources. Like a slingshot in the open air, this cable projects light installations, giving life to spectacular geometries and configurations that are always unexpected. Straight from our childhood, Sling plays with simplicity and endless variables.**

Modular suspension lamp. Die-casted aluminium structure.

LIST PRICE :

\$ 220

DRIVER KIT: \$ 350



Black

## DRIVER KIT

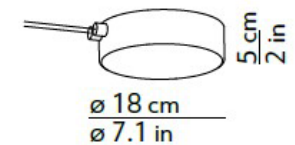

# KATE

FRANCESCA SMIRAGLIA / 2023

MODEL . MOTUS . KOOI . SLING . KATE . FLOW . MITOS . POISE . DALA . JER . BOLHA . TYLA . FLOED . NAMI . VICEVERSA . GIASS . EVITA . E.T.A . SHAKTI . TATU . LANNÀ . HIVE . LILLI . OPYO . DEW . MINIMAL . YUMA . KUSHI . KYUDO . AZOU



## KATE 2700 K

board LED 1x60W  
2700 K - 6600 lm - CRI>90

## KATE 3000 K

board LED 1x60W  
3000 K - 6835 lm - CRI>90

220-240 / 120V

Dimmerabile taglio di fase

CLASS 1 - IP20 - CE

**Architectural forms and unconventional dimensions. The headgear worn by the Duchess of Cambridge for the 70<sup>th</sup> anniversary of the English jubilee inspires Kate, the ceiling light that rewrites the perceptual rules of space. This conical lamp is positioned on the ceiling with an inclination of 15 degrees in order to diffuse the light in an unexpected way.**

Ceiling lamp with opal diffuser. Aluminium coated structure available in colours on request.

LIST PRICE :

WHITE: \$ 1.950

COLOURS ON REQUEST: \$ 2.150



White



Customizable RAL colour on request.  
No minimum quantity.

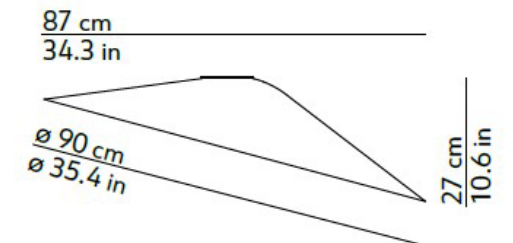



# FLOW CEILING

CHRIS BASIAS / 2022

MODEL T . MOTUS . KOOI . SLING . KATE . FLOW . MITOS . POISE . DALA . JER . BOLHA . TYLA . FLOED . NAMI . VICEVERSA . GIASS . EVITA . E.T.A . SHAKTI . TATU . LANNÀ . HIVE . LILLI . OPYO . DEW . MINIMAL . YUMA . KUSHI . KYUDO . AZOU



## FLOW

1x25W max - G9

120V

Dimmerabile

**“Floating Leaves Out of the Window”**. The metallic disc of the lamp imitates the shape of the leaves of a tree, blown by the wind. With or without light, the elements can be combined to, make touching installations. Playing with ,shadows and lights, Flow reproduces the dance of nature on a windy day.

Suspension and ceiling lamp. Opal diffuser made of two layers of blown glass. Metallic coated structure.

LIST PRICE

FLOW CEILING: \$ 610

LEAF: \$ 310



Black

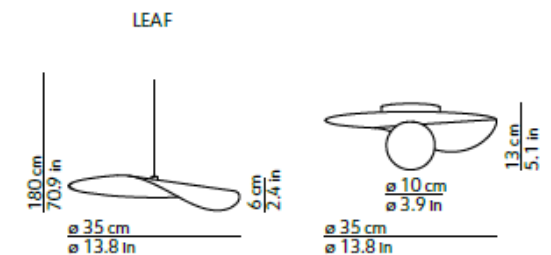



# FLOW

CHRIS BASIAS / 2022

MODEL T . MOTUS . KOOI . SLING . KATE . FLOW . MITOS . POISE . DALA . JER . BOLHA . TYLA . FLOED . NAMI . VICEVERSA . GIASS . EVITA . E.T.A . SHAKTI . TATU . LANNÀ . HIVE . LILLI . OPYO . DEW . MINIMAL . YUMA . KUSHI . KYUDO . AZOU



**FLOW**  
1x25W max - G9

120V

Dimmerabile

**“Floating Leaves Out of the Window”**. The metallic disc of the lamp imitates the shape of the leaves of a tree, blown by the wind. With or without light, the elements can be combined to, make touching installations. Playing with shadows and lights, Flow reproduces the dance of nature on a windy day.

Suspension and ceiling lamp. Opal diffuser made of two layers of blown glass. Metallic coated structure.

#### LIST PRICE

FLOW: \$ 590

LEAF: \$ 310

#### ACCESSORIES

black canopy: \$ 160

black false ceiling canopy: \$ 100

black multiple canopy: \$ 550



Black

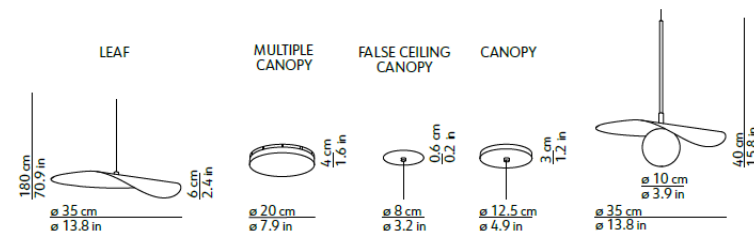

# POISE CEILING

ROBERT DABI / 2022

MODEL T . MOTUS . KOOI . SLING . KATE . FLOW . MITOS . POISE . DALA . JER . BOLHA . TYLA . FLOED . NAMI . VICEVERSA . GIASS . EVITA . E.T.A . SHAKTI . TATU . LANNÀ . HIVE . LILLI . OPYO . DEW . MINIMAL . YUMA . KUSHI . KYUDO . AZOU



## POISE CEILING

strip LED 1x28W  
2700 K - 3600 lm - CRI>90

120V

Dimmable phase cut

**In Poise, human curiosity and the interaction with light source, are encouraged by the flexible section between frame and the circle, allowing the latter to be moved into any position. A vitality capable of creating ever-changing configurations defying gravity.**

Ceiling lamp. Technical, fabric coated flexible tube. Matt black metallic diffuser and structure.

### PRICE LIST

\$ 1050

● Black

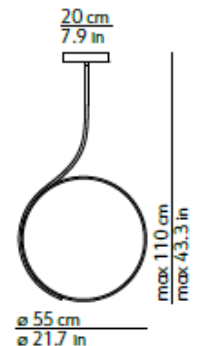

# POISE FLOOR

ROBERT DABI / 2022

MODEL T . MOTUS . KOOI . SLING . KATE . FLOW . MITOS . POISE . DALA . JER . BOLHA . TYLA . FLOED . NAMI . VICEVERSA . GIASS . EVITA . E.T.A . SHAKTI . TATU . LANNÀ . HIVE . LILLI . OPYO . DEW . MINIMAL . YUMA . KUSHI . KYUDO . AZOU

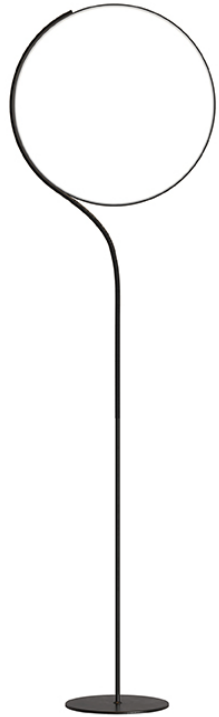

**POISE FLOOR**  
strip LED 1x28W  
2700 K - 3600 lm - CRI>90

120V

Dimmerabile

**In Poise, human curiosity and the interaction with light source, are encouraged by the flexible section between frame and the circle, allowing the latter to be moved into any position. A vitality capable of creating ever-changing configurations defying gravity.**

Dimmable floor lamp. Technical fabric coated flexible tube. Matt black metallic diffuser and structure

LIST PRICE  
\$ 1150

● Black

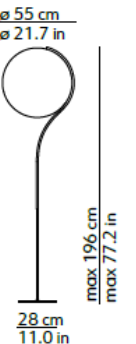

# POISE

ROBERT DABI / 2021

MODEL T . MOTUS . KOOI . SLING . KATE . FLOW . MITOS . POISE . DALA . JER . BOLHA . TYLA . FLOED . NAMI . VICEVERSA . GIASS . EVITA . E.T.A . SHAKTI . TATU . LANNÀ . HIVE . LILLI . OPYO . DEW . MINIMAL . YUMA . KUSHI . KYUDO . AZOU



**POISE**  
strip LED 1x13.5W  
2700 K - 1050 lm - CRI>90

120V

Dimmer included

**A circle of light and a metal rod. Slender, lightweight and adjustable up to 320 degrees, they can be moved as one to create ever-changing configurations. The solid T-shaped base acts as a counterweight. The rod is placed at a tangent to the circle, in acrobatic or static poses. An invitation for two-way interaction with the light.**

Dimmable table lamp. Matt black metallic diffuser and structure adjustable up to 320 degrees.

LIST PRICE  
\$ 710

● Black

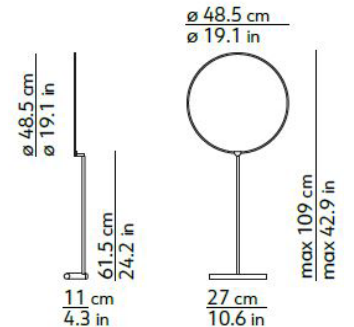

# DALA LINEAR

FRANCESCA SMIRAGLIA / 2022

MODEL T . MOTUS . KOOI . SLING . KATE . FLOW . MITOS . POISE . DALA . JER . BOLHA . TYLA . FLOED . NAMI . VICEVERSA . GIASS . EVITA . E.T.A . SHAKTI . TATU . LANNÀ . HIVE . LILLI . OPYO . DEW . MINIMAL . YUMA . KUSHI . KYUDO . AZOU

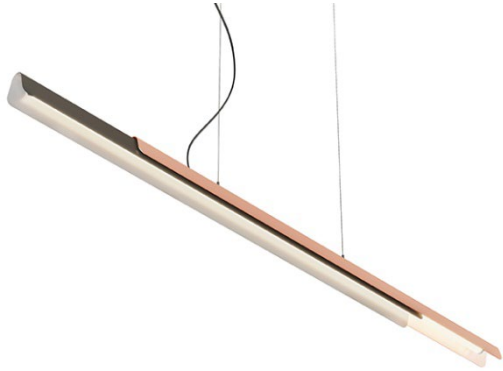

## DALA LINEAR

board LED 1x42W  
2700 K - 5150 lm - CRI>90

## DALA LINEAR 3000 K

board LED 1x42W  
3000 K - 5300 lm - CRI>90

120V

Dimmable phase cut

A harmonious synthesis of form and function is traced by two linear elements of different sizes that frame the white diffuser overlapping each other like the petals of a flower. Thanks to the different combinations of finishes, Dala Linear integrates elegantly into collective and residential spaces.

Suspension lamp with opal diffuser. Metallic coated structure available in six colour configurations.

### LIST PRICE

Dark grey+wood finish: \$2280

Sand+wood: \$ 2280

Dark grey+concrete finish: \$ 2280

Sand+concrete: \$ 2280

Dark grey+copper: \$ 2280

Sand+copper: \$ 2280

Dark grey + copper

Dark grey + concrete finish

Dark grey + wood finish

Sand + wood

sand + concrete

Sand + copper

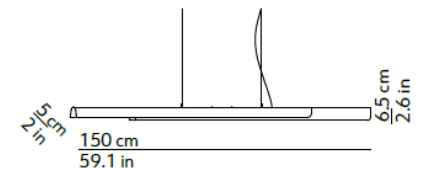



# DALA

FRANCESCA SMIRAGLIA / 2021

MODEL T . MOTUS . KOOI . SLING . KATE . FLOW . MITOS . POISE . DALA . JER . BOLHA . TYLA . FLOED . NAMI . VICEVERSA . GIASS . EVITA . E.T.A . SHAKTI . TATU . LANNÀ . HIVE . LILLI . OPYO . DEW . MINIMAL . YUMA . KUSHI . KYUDO . AZOU



**DALA**  
board LED 1x42W  
2700 K - 4200 lm - CRI>90

**DALA**  
board LED 1x42W  
3000 K - 4350 lm - CRI>90

120V

Dimmable phase cut

**Highly decorative with an architectural look, Dala blends fluid lines with a strong design. The two outer metal casings wrap around the large diffuser, overlapping like the petals of a flower. In two different sizes, featuring a sophisticated contrast in colours, reminiscent of the natural shape of the flower's corolla which envelops the light.**

Ceiling lamp with opal diffuser. Metallic coated structure available in six colour configurations.

#### LIST PRICE

Dark grey+wood finish: \$ 2280

Sand+wood: \$ 2280

Dark grey+concrete finish: 2280

Sand+concrete: \$ 2280

Dark grey+copper: \$ 2280

Sand+copper: \$ 2280

White: \$ 1990

 Dark grey + copper

 Dark grey + concrete finish

 Dark grey + wood finish

 Sand + wood

 sand + concrete

 Sand + copper

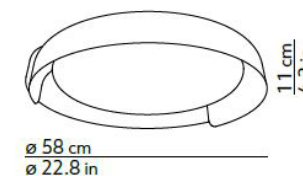

# JER

VALERIO SOMMELLA & ANONIMA LUCI / 2021

MODEL T . MOTUS . KOOI . SLING . KATE . FLOW . MITOS . POISE . DALA . JER . BOLHA . TYLA . FLOED . NAMI . VICEVERSA . GIASS . EVITA . E.T.A . SHAKTI . TATU . LANNÀ . HIVE . LILLI . OPYO . DEW . MINIMAL . YUMA . KUSHI . KYUDO . AZOU



**JER**  
board LED 1x4.5W  
2700 K - 540 lm - CRI>90

120 V

Dimmable phase cut

**Elegant geometric patterns, ground by hand, are traced on the glass. The shapes and decorations are reminiscent of collections of old-fashioned cut glass with a contemporary twist. Jer can be used to compose groups of multiple elements, ideal for illuminating large spaces.**

Suspension lamp. Mouth blown glass and hand ground diffuser available in three smokey finishes: blue, brown and green. Cable length: 180 cm / 70,9 in

-  Smokey blue
-  Smokey brown
-  Smokey green

LIST PRICE  
JER 1: \$ 1400

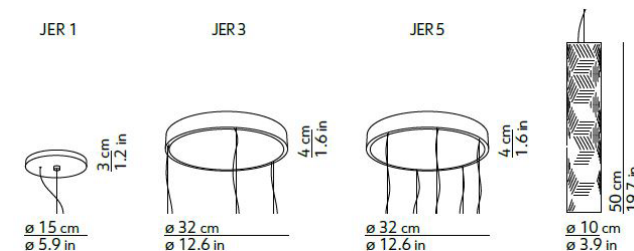



# BOLHA

VALERIO SOMMELLA & ANONIMA LUCI / 2021

MODEL T . MOTUS . KOOI . SLING . KATE . FLOW . MITOS . POISE . DALA . JER . BOLHA . TYLA . FLOED . NAMI . VICEVERSA . GIASS . EVITA . E.T.A . SHAKTI . TATU . LANNÀ . HIVE . LILLI . OPYO . DEW . MINIMAL . YUMA . KUSHI . KYUDO . AZOU



**An ethereal, transparent bubble for the diffuser. A textured inner cylinder for the light source which resembles the filaments of traditional incandescent light bulbs. The continuously refracted light takes on a tangible appearance thanks to the interaction between the two elements.**

Suspension lamp. External glass made of transparent borosilicate. Internal diffuser made of mouth blown glass available in two finishes. Metallic coated structure.

Cable length: 180 cm / 70,9 in

LIST PRICE  
\$ 3480

- Amber
- Smokey brown

**BOLHA**  
board LED 1x19W  
2700 K - 2200 lm - CRI>90

120V

Dimmable phase cut

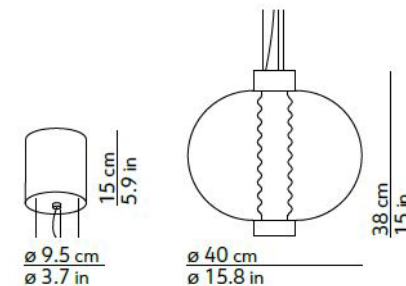

# TYLA

MARC SADLER / 2021

MODEL T . MOTUS . KOOI . SLING . KATE . FLOW . MITOS . POISE . DALA . JER . BOLHA . TYLA . FLOED . NAMI . VICEVERSA . GIASS . EVITA . E.T.A . SHAKTI . TATU . LANNÀ . HIVE . LILLI . OPYO . DEW . MINIMAL . YUMA . KUSHI . KYUDO . AZOU



## TYLA

1x70W max - E27 (E26)

120V

Dimmer included

ETL CANADA + USA

The long slender stems of the bulrush, an elegant aquatic plant, are the inspiration behind the elements which support this light with a delicate, almost lyrical design. And the same movement of the plant in the wind is reflected in the unusual lampshade. A slightly irregular shape, featuring opaque glass on the inside and clear glass on the outside, brought to life by the bright faceted surface.

Dimmable floor lamp. Diffuser made of sandblasted mouth blown glass. Metallic coated structure.

LIST PRICE

\$ 2240

Dark blue

White

Red

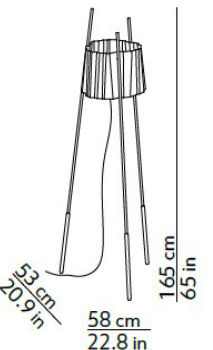

# FLOED

STORAGE MILANO / 2020

MODEL T . MOTUS . KOOI . SLING . KATE . FLOW . MITOS . POISE . DALA . JER . BOLHA . TYLA . FLOED . NAMI . VICEVERSA . GIASS . EVITA . E.T.A . SHAKTI . TATU . LANNÀ . HIVE . LILLI . OPYO . DEW . MINIMAL . YUMA . KUSHI . KYUDO . AZOU



**FLOED**  
1x70W max - E27 (E26)  
L 10.5 cm max

120V

Dimmable

ETL CANADA + USA

**The surprising shapes of gorgonian coral inspire a structure of great visual and material impact. Between nature, art and architecture, a lamp installation with a strong and magnetic presence. The size of the blunt cylinder in opaline glass and the aluminium bar that make up Floed are impressive. For wall or ceiling surface-mounted installation.**

Ceiling and wall lamp. Opal diffuser made of two layers of blown glass. Metallic coated structure.

LIST PRICE  
\$ 1990

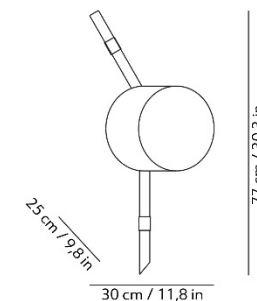

# FLOED 2

STORAGE MILANO / 2020

MODEL T . MOTUS . KOOI . SLING . KATE . FLOW . MITOS . POISE . DALA . JER . BOLHA . TYLA . FLOED . NAMI . VICEVERSA . GIASS . EVITA . E.T.A . SHAKTI . TATU . LANNÀ . HIVE . LILLI . OPYO . DEW . MINIMAL . YUMA . KUSHI . KYUDO . AZOU

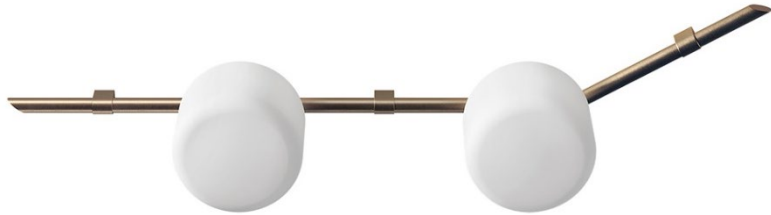

## FLOED 2

2x70W max - E27 (E26)

L 10.5 cm max

120V

Dimmable

ETL CANADA + USA

The surprising shapes of gorgonian coral inspire a structure of great visual and material impact. Between nature, art and architecture, a lamp installation with a strong and magnetic presence. The size of the blunt cylinder in opaline glass and the aluminium bar that make up Floed are impressive. For wall or ceiling surface-mounted installation.

Ceiling and wall lamp. Opal diffuser made of two layers of blown glass. Metallic coated structure.

**kdl**n

LIST PRICE

\$ 3390



Bronze

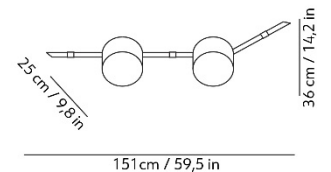

# NAMI WALL

A.SAGGIA & V.SOMMELLA / 2020

MODEL T . MOTUS . KOOI . SLING . KATE . FLOW . MITOS . POISE . DALA . JER . BOLHA . TYLA . FLOED . NAMI . VICEVERSA . GIASS . EVITA . E.T.A . SHAKTI . TATU . LANNÀ . HIVE . LILLI . OPYO . DEW . MINIMAL . YUMA . KUSHI . KYUDO . AZOU



**NAMI WALL**  
board LED 1x12W  
2700 K - 1750 lm - CRI>90

120V

Dimmable phase cut

**Elegant and mysterious. A wave of glass and light emerges from an essential metal element. Precious grooves reveal multiple light refractions. Nami, "wave" in Japanese, unleashes the reflections of the sea in a continuous play of perspectives. Now also in the functional wall-mounted version, alongside the suspended model.**

Wall lamp with textured and curved glass diffuser. Die-casted varnished aluminium structure.

LIST PRICE  
\$ 675

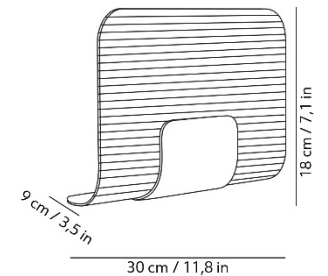
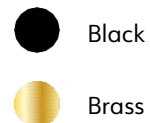



# NAMI

A.SAGGIA & V.SOMMELLA / 2017

MODEL T . MOTUS . KOOI . SLING . KATE . FLOW . MITOS . POISE . DALA . JER . BOLHA . TYLA . FLOED . NAMI . VICEVERSA . GIASS . EVITA . E.T.A . SHAKTI . TATU . LANNÀ . HIVE . LILLI . OPYO . DEW . MINIMAL . YUMA . KUSHI . KYUDO . AZOU



NAMI  
board LED 4x15W  
2700 K - 2520x2 lm - CRI>90

120V

Dimmable 1-10 V

**Nami, which means “wave” in Japanese, creates a continuous, eye-catching refraction of light. The diffuser, with its signature elegant grooves, opens unexpectedly at the sides to amplify the reflections of light. The graphic outline of the structure creates a visual contrast with the glass surface in an innovative balance between solidity and lightness.**

Suspension lamp with textured and curved glass diffuser.  
Die-casted varnished aluminium structure.  
Cable length: 180 cm / 70,9 in

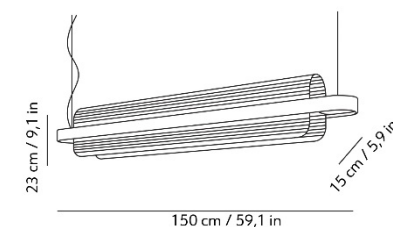
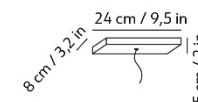

**kdl**n

LIST PRICE  
\$ 3900

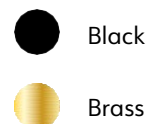

# VICEVERSA

NOÉ DUCHAUFOR LAWRENCE / 2020

MODEL T . MOTUS . KOOI . SLING . KATE . FLOW . MITOS . POISE . DALA . JER . BOLHA . TYLA . FLOED . NAMI . VICEVERSA . GIASS . EVITA . E.T.A . SHAKTI . TATU . LANNÀ . HIVE . LILLI . OPYO . DEW . MINIMAL . YUMA . KUSHI . KYUDO . AZOU



**Light/nature. Structure/life. Sculpture/movement. Viceversa. Multiple readings for a unique object. A simple rotation and the suspended lamp suddenly makes space for plant elements. Bright vertical gardens take shape. Dreamlike and vibrant scenes, which reconnect the inhabited space with the breath of greenery.**

Suspension lamp. Diffuser made of mouth blown glass and metallic structure.  
Cable length: 180 cm / 70,9 in

#### LIST PRICE

VICEVERSA \$ 2690

VICEVERSA 2 \$ 4950

● Smokey grey

● Amber

#### VICEVERSA

board LED 1x6.5W  
2700 K - 800 lm - CRI>90

#### VICEVERSA 2

board LED 2x6.5W  
2700 K - 1600 lm - CRI>90

120V

Dimmable 1-10 V

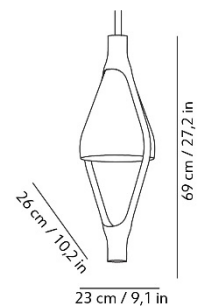
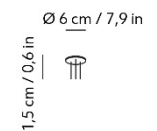
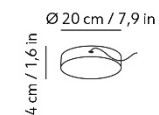



# GIASS 25

SEBASTIAN HERKNER / 2017

MODEL T . MOTUS . KOOI . SLING . KATE . FLOW . MITOS . POISE . DALA . JER . BOLHA . TYLA . FLOED . NAMI . VICEVERSA . GIASS . EVITA . E.T.A . SHAKTI . TATU . LANNÀ . HIVE . LILLI . OPYO . DEW . MINIMAL . YUMA . KUSHI . KYUDO . AZOU



## GIASS 25

board LED 1x19W  
2700 K - 1700 lm - CRI>90

120 V

Dimmable 1-10 V

CLASS 1 - IP20 - CE - EAC

The glass of tumblers and ice, "giass" in Milanese dialect. The retro style of bars from a by-gone era. A world reinterpreted with a modern vision. Continuous reflections and iridescent light and the possibility of creating numerous combinations at will. The elements in four different sizes and two colour variations leave ample room for compositional freedom.

Ceiling lamp with blown and sandblasted or coloured glass diffuser, available in four different dimensions. Coated metal structure, satin polycarbonate screen.

LIST PRICE:  
\$ 2750

 Smokey grey

 White

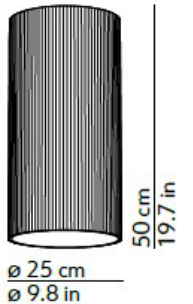

# GIASS 30

SEBASTIAN HERKNER / 2017

MODEL T . MOTUS . KOOI . SLING . KATE . FLOW . MITOS . POISE . DALA . JER . BOLHA . TYLA . FLOED . NAMI . VICEVERSA . GIASS . EVITA . E.T.A . SHAKTI . TATU . LANNÀ . HIVE . LILLI . OPYO . DEW . MINIMAL . YUMA . KUSHI . KYUDO . AZOU



## GIASS 30

board LED 1x25W  
2700 K - 2250 lm - CRI>90

120 V

Dimmable 1-10 V

CLASS 1 - IP20 - CE - EAC

The glass of tumblers and ice, "giass" in Milanese dialect. The retro style of bars from a by-gone era. A world reinterpreted with a modern vision. Continuous reflections and iridescent light and the possibility of creating numerous combinations at will. The elements in four different sizes and two colour variations leave ample room for compositional freedom.

Ceiling lamp with blown and sandblasted or coloured glass diffuser, available in four different dimensions. Coated metal structure, satin polycarbonate screen.

LIST PRICE:  
\$ 3250

 Smokey grey

 White

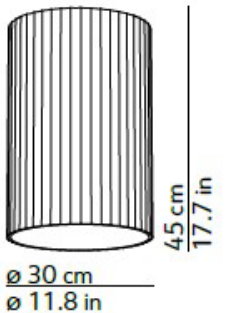

# GIASS 40

SEBASTIAN HERKNER / 2017

MODEL T . MOTUS . KOOI . SLING . KATE . FLOW . MITOS . POISE . DALA . JER . BOLHA . TYLA . FLOED . NAMI . VICEVERSA . GIASS . EVITA . E.T.A . SHAKTI . TATU . LANNÀ . HIVE . LILLI . OPYO . DEW . MINIMAL . YUMA . KUSHI . KYUDO . AZOU



## GIASS 40

board LED 1x35W  
2700 K - 3100 lm - CRI>90

120 V

Dimmable 1-10 V

CLASS 1 - IP20 - CE - EAC

The glass of tumblers and ice, "giass" in Milanese dialect. The retro style of bars from a by-gone era. A world reinterpreted with a modern vision. Continuous reflections and iridescent light and the possibility of creating numerous combinations at will. The elements in four different sizes and two colour variations leave ample room for compositional freedom.

Ceiling lamp with blown and sandblasted or coloured glass diffuser, available in four different dimensions. Coated metal structure, satin polycarbonate screen.

LIST PRICE:  
\$ 3650

 Smokey grey

 White

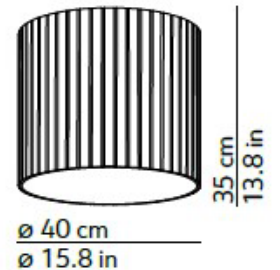

# GIASS 50

SEBASTIAN HERKNER / 2017

MODEL T . MOTUS . KOOI . SLING . KATE . FLOW . MITOS . POISE . DALA . JER . BOLHA . TYLA . FLOED . NAMI . VICEVERSA . GIASS . EVITA . E.T.A . SHAKTI . TATU . LANNÀ . HIVE . LILLI . OPYO . DEW . MINIMAL . YUMA . KUSHI . KYUDO . AZOU



## GIASS 50

board LED 1x44W  
2700 K - 3950 lm - CRI>90

120 V

Dimmable 1-10 V

CLASS 1 - IP20 - CE - EAC

The glass of tumblers and ice, "giass" in Milanese dialect. The retro style of bars from a by-gone era. A world reinterpreted with a modern vision. Continuous reflections and iridescent light and the possibility of creating numerous combinations at will. The elements in four different sizes and two colour variations leave ample room for compositional freedom.

Ceiling lamp with blown and sandblasted or coloured glass diffuser, available in four different dimensions. Coated metal structure, satin polycarbonate screen.

LIST PRICE:  
\$ 3990

 Smokey grey

 White

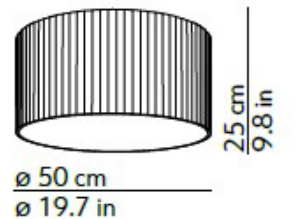

# EVITA

AQUILIALBERG / 2011

MODEL T . MOTUS . KOOI . SLING . KATE . FLOW . MITOS . POISE . DALA . JER . BOLHA . TYLA . FLOED . NAMI . VICEVERSA . GIASS . EVITA . E.T.A . SHAKTI . TATU . LANNÀ . HIVE . LILLI . OPYO . DEW . MINIMAL . YUMA . KUSHI . KYUDO . AZOU



**EVITA**  
2x54W - T5 fluorescent  
or compatible LED light source

120V

Dimmable

CLASS 1 - IP20 - CE - EAC

**The name conjures up a woman of immense charm and character who inspired films, music and literature. It conveys a decisive, yet delicate elegance in its sinuous, unpredictable shape. The special elastic fabric, normally used in other contexts, wraps around the body of the light like a garment, creating unexpected curves.**

Dimmable floor lamp. Composite body structure of multilayered steel and technopolymers, thermos extensible fabric diffuser.

**kdl**<sup>®</sup>

LIST PRICE:  
\$ 3810



Black RAL9005



Dove-grey RAL7006



White RAL1013



Red RAL3003

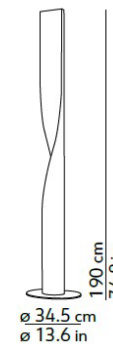



# E.T.A

GUGLIELMO BERCHICCI / 1996

MODEL T . MOTUS . KOOI . SLING . KATE . FLOW . MITOS . POISE . DALA . JER . BOLHA . TYLA . FLOED . NAMI . VICEVERSA . GIASS . EVITA . E.T.A . SHAKTI . TATU . LANNÀ . HIVE . LILLI . OPYO . DEW . MINIMAL . YUMA . KUSHI . KYUDO . AZOU



## E.T.A.

3x40W max - E12 +  
1x100W max - E26

120V

Dimmable

CLASS 2 - IP20 - CE - EAC

**Craftsmanship and materials in a fascinating combination. A floor lamp in fibreglass shaped by hand. A sinuous object flooded with light that seems to arrive from faraway worlds to grace the space it occupies.**

Dimmable floor lamp. Handmade light diffuser in ecological fiberglass, metallic inner structure (removable for bulbs changing).

**kdl**<sup>ni</sup>

LIST PRICE:  
\$ 3190

 Orange

 White

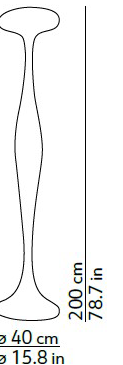

# E.T.A SAT

GUGLIELMO BERCHICCI / 1996

MODEL T . MOTUS . KOOI . SLING . KATE . FLOW . MITOS . POISE . DALA . JER . BOLHA . TYLA . FLOED . NAMI . VICEVERSA . GIASS . EVITA . E.T.A . SHAKTI . TATU . LANNÀ . HIVE . LILLI . OPYO . DEW . MINIMAL . YUMA . KUSHI . KYUDO . AZOU



## E.T.A.

1x40W max - E12 +

1x100W max - E26

120V

Dimmable

CLASS 2 - IP20 - CE - EAC

**The material is transformed and turned into a light. Physical presence and abstract concept for a light with an original aesthetic look. Fluid, irregular shapes create an innovative, eye-catching equilibrium. A highly decorative object, ideal for communal spaces and show-stopping contract settings.**

Suspension lamp. Handmade light diffuser in ecological fiberglass, with polycarbonate reflector, metallic inner structure.

**kdl**n

LIST PRICE:

\$ 2640

 Orange

 White

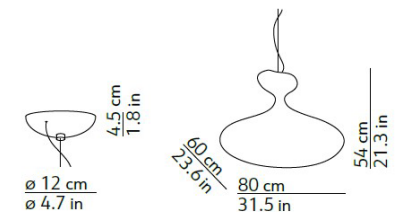



# SHAKTI

MARZIO RUSCONI CLERICI / 2001

MODEL T . MOTUS . KOOI . SLING . KATE . FLOW . MITOS . POISE . DALA . JER . BOLHA . TYLA . FLOED . NAMI . VICEVERSA . GIASS . EVITA . E.T.A . SHAKTI . TATU . LANNÀ . HIVE . LILLI . OPYO .  
DEW . MINIMAL . YUMA . KUSHI . KYUDO . AZOU



## SHAKTI

2x100W max - E26

120V

Dimmable

CLASS 2 - IP20 - CE - EAC

**Industrial language finds an unusual expression and plays on simple, clean lines. The tubular diffuser, sliced diagonally at both ends, acquires a new impetus. Formal purity for a floor lamp that is always up-to-date.**

Floor lamp with two lights for reading and ambient that can be dimmed. The light diffuser is a laser cut extruded Plexiglas tube, fixed into a satin finished or polished stainless steel base.

LIST PRICE:

**SHAKTI 200 satin base: \$ 1870**

**SHAKTI 200 polished base: \$ 1990**

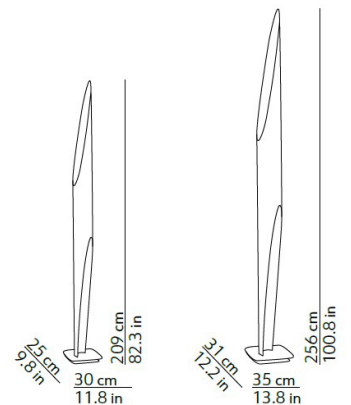

# SHAKTI WALL FIX 80

MARZIO RUSCONI CLERICI / 2002

MODEL T . MOTUS . KOOI . SLING . KATE . FLOW . MITOS . POISE . DALA . JER . BOLHA . TYLA . FLOED . NAMI . VICEVERSA . GIASS . EVITA . E.T.A . SHAKTI . TATU . LANNÀ . HIVE . LILLI . OPYO . DEW . MINIMAL . YUMA . KUSHI . KYUDO . AZOU

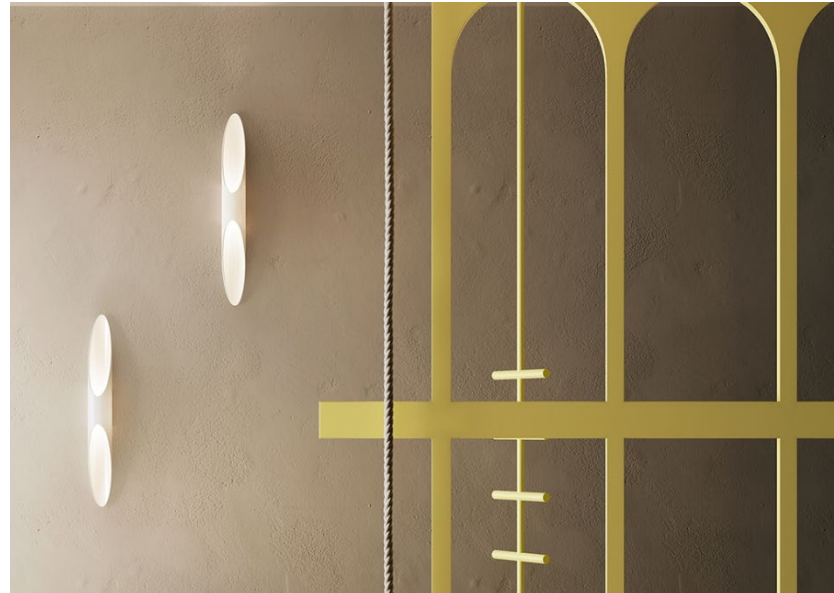

## SHAKTI WALL FIX 80

1x60W max - E26

120V

Dimmable

CLASS 1 - IP20 - CE - EAC

**A cylinder and two diagonal cuts at the ends for an object of extreme purity. The light seems to become one with the diffuser. The lamps, if arranged in sequence, add a new sense of rhythm to spaces and walls.**

Double light wall lamp with tubular light diffuser in laser cut Plexiglas.

LIST PRICE:

\$ 620



White

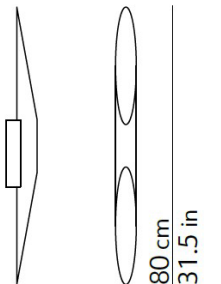

80 cm  
31.5 in  
ø 10 cm  
ø 3.9 in

# TATU

MRSMITH STUDIO / 2019

MODEL T . MOTUS . KOOI . SLING . KATE . FLOW . MITOS . POISE . DALA . JER . BOLHA . TYLA . FLOED . NAMI . VICEVERSA . GIASS . EVITA . E.T.A . SHAKTI . TATU . LANNÀ . HIVE . LILLI . OPYO . DEW . MINIMAL . YUMA . KUSHI . KYUDO . AZOU



## TATU

1x100W max - E27 (E26)

120V

Dimmer included

**Tatu, which means “three” in Swahili, consists of slimline triangular shapes. The lightweight, slimline structure frames the satin-finish glass light allowing it to shine through. Elegant contrasts between solid and hollow elements for a contemporary take on the classic table lamp, resulting in a unique, signature look.**

Dimmable table lamp. Opal diffuser made of blown glass. Coated or satin slender brass structure.

LIST PRICE

\$ 1820

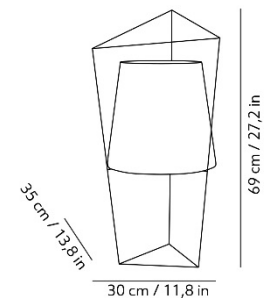
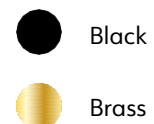

# LANNÀ TABLE

NOÉ DUCHAUFOUR LAWRENCE / 2019

MODEL T . MOTUS . KOOI . SLING . KATE . FLOW . MITOS . POISE . DALA . JER . BOLHA . TYLA . FLOED . NAMI . VICEVERSA . GIASS . EVITA . E.T.A . SHAKTI . TATU . LANNÀ . HIVE . LILLI . OPYO . DEW . MINIMAL . YUMA . KUSHI . KYUDO . AZOU



## LANNÀ TABLE

1x20W max - E27 (E26)

Ø 6 cm max

120V

ETL USA

**A beguiling, lightweight design for a table lamp that is reminiscent of the fascinating tradition of the Lanna. This ancient Thai population used to release hundreds of lanterns into the night sky during festivals. And it is as if one of these had floated down into the most sophisticated and contemporary interiors, recreating the magic with its warm, welcoming light.**

Table lamp. Opal diffuser made of blown glass. Metallic coated structure.

LIST PRICE

\$ 1190

 Black

 Brass

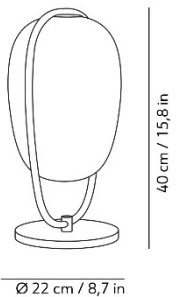

# LANNÀ SUSPENSION

NOÉ DUCHAUFOUR LAWRENCE / 2019

MODEL T . MOTUS . KOOI . SLING . KATE . FLOW . MITOS . POISE . DALA . JER . BOLHA . TYLA . FLOED . NAMI . VICEVERSA . GIASS . EVITA . E.T.A . SHAKTI . TATU . LANNÀ . HIVE . LILLI . OPYO . DEW . MINIMAL . YUMA . KUSHI . KYUDO . AZOU



**A contemporary lightness, an ancient rite. The rite of the Lanna, the Thai people, who every year release hundreds of lanterns into the starlit sky. The glass diffuser, balanced in the suspended metal structure, appears ethereal and sophisticated. Intimate, dreamlike atmospheres in the bedroom and all the interiors of home and contract settings alike.**

Suspension lamp. Opal diffuser made of blown glass.  
Metallic coated structure.  
Cable length: 180 cm / 70,9 in

LIST PRICE

\$ 1005

- Black
- Brass

LANNÀ SUSPENSION  
1x20W max - E27 (E26)

ø 6 cm max  
120V

Dimmable

ETL CANADA + USA

Ø 12,5 cm / 4,9 in

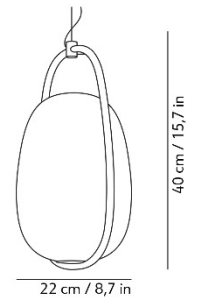
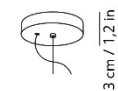



# HIVE

INI ARCHIBONG / 2019

MODEL T . MOTUS . KOOI . SLING . KATE . FLOW . MITOS . POISE . DALA . JER . BOLHA . TYLA . FLOED . NAMI . VICEVERSA . GIASS . EVITA . E.T.A . SHAKTI . TATU . LANNÀ . HIVE . LILLI . OPYO . DEW . MINIMAL . YUMA . KUSHI . KYUDO . AZOU



HIVE  
1x30W max - E27 (E26)

120V

ETL USA

**The purity of Art Déco in the shapes. The allure of ancient Japanese ceramics in the pattern which envelops the body of the lamp. The freedom to merge styles and influences to create a one-of-a-kind object and the third firing technique to produce fine decoration in pure gold. A light, delicate design produced using multiple firings of the ceramic.**

Table lamp. Opal diffuser made of blown glass.  
Lacquered ceramic body decorated with the "third fire" technique.

LIST PRICE  
\$ 1320

● Black

● White

● Red

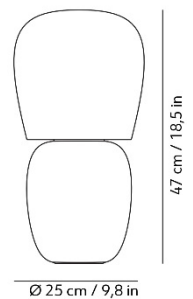

kdl<sup>ni</sup>

# LILLI

CRISTINA CELESTINO/ 2019

MODEL T . MOTUS . KOOI . SLING . KATE . FLOW . MITOS . POISE . DALA . JER . BOLHA . TYLA . FLOED . NAMI . VICEVERSA . GIASS . EVITA . E.T.A . SHAKTI . TATU . LANNÀ . HIVE . LILLI . OPYO . DEW . MINIMAL . YUMA . KUSHI . KYUDO . AZOU



LILLI

3x42W max - E14 (E12)

120V

Dimmable

ETL CANADA + USA

**As in a sophisticated collection of botanical drawings, the delicate lines of Lilli recall the beauty of a rare flower. The delicate inverted corolla of the Martagon Lily is reinterpreted in an original lamp. The soft shape of the white opal glass diffuser is perfectly combined with the brass pistil to create an even more elegant effect.**

Suspension lamp. Opal diffuser made of blown glass.  
Satin brass structure.  
Cable length: 180 cm / 70,9 in

LIST PRICE

\$ 1660



Brass

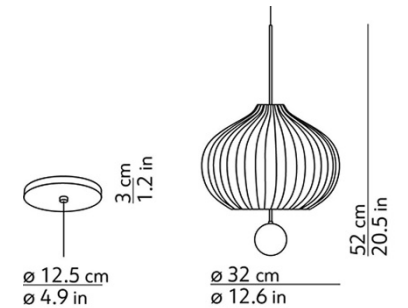

kdlIn



# OPYO FLOOR

CRISTINA CELESTINO / 2019

MODEL T . MOTUS . KOOI . SLING . KATE . FLOW . MITOS . POISE . DALA . JER . BOLHA . TYLA . FLOED . NAMI . VICEVERSA . GIASS . EVITA . E.T.A . SHAKTI . TATU . LANNÀ . HIVE . LILLI . OPYO . DEW . MINIMAL . YUMA . KUSHI . KYUDO . AZOU



## OPYO FLOOR

1x70W max - E27 (E26)

120V

Dimmer included

ETL CANADA + USA

The intelligence of nature with its perfect and unexpected forms is the inspiration behind the Opyo design. The delicate, clean lines of the poppy seed pod inspire the opal glass diffuser. It is supported by a long metal stem, just like the flower. A floor lamp which brings the harmonious mystery of the botanical world indoors.

Dimmable floor lamp. Opal diffuser made of blown glass. Metallic coated structure.

**kdl**n

LIST PRICE

\$ 2150

White

Brass

Coral



# OPYO SUSPENSION

CRISTINA CELESTINO / 2019

MODEL T . MOTUS . KOOI . SLING . KATE . FLOW . MITOS . POISE . DALA . JER . BOLHA . TYLA . FLOED . NAMI . VICEVERSA . GIASS . EVITA . E.T.A . SHAKTI . TATU . LANNÀ . HIVE . LILLI . OPYO . DEW . MINIMAL . YUMA . KUSHI . KYUDO . AZOU



## OPYO FLOOR

1x70W max - E27 (E26)

120V

Dimmable

ETL CANADA + USA

**The infinite abundance of shapes in the natural world has always inspired art and design. The simple, harmonious lines of the poppy seed pod appear as if by magic in Opyo. The suspended version is a sophisticated design object. One individual lamp or multiple lamps placed side by side conjure up an evocative, refined atmosphere.**

Suspension lamp. Opal diffuser made of blown glass.  
Metallic coated structure.  
Cable length: 180 cm / 70,9 in

LIST PRICE

\$ 890

White

Brass

Coral

Ø 12,5 cm / 4,9 in

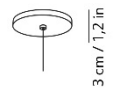

3 cm / 1,2 in

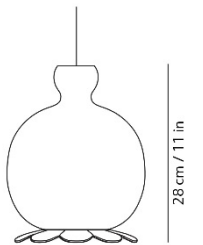

Ø 22 cm / 8,7 in

# DEW

EMMANUEL BABLED / 2009

MODEL . MOTUS . KOOI . SLING . KATE . FLOW . MITOS . POISE . DALA . JER . BOLHA . TYLA . FLOED . NAMI . VICEVERSA . GIASS . EVITA . E.T.A . SHAKTI . TATU . LANNÀ . HIVE . LILLI . OPYO .  
DEW . MINIMAL . YUMA . KUSHI . KYUDO . AZOU



**Glass drops suspended in space like dew. A system that allows for total compositional freedom. From two to an infinite number of elements to create a chandelier of all shapes and sizes, from cascades to strings of light.**

Suspension lamp with die cast aluminium heat sink and a 1,5 kg weight glass diffuser. High voltage power led. It can be realized on demand as a multiple pendant chandelier. Cable length: 250 cm / 98,4 in

## DEW - DEW FALSE CEILING

board LED 1x5W  
2700 K - 440 lm - CRI>90

## DEW 3

board LED 3x5W  
2700 K - 1320 lm - CRI>90

120V

Dimmable phase cut

ETL CANADA + USA

**kdl**<sup>®</sup>

### LIST PRICE

DEW: chrome \$ 880 / black-brass \$ 940

DEW 3: chrome \$ 2590 / black-brass \$ 2790

 Chrome

 Black (on request)

 Brass (on request)

Ø 12,5 cm / 4,9 in



3 cm / 1,2 in

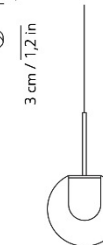

Ø 11 cm / 4,3 in

Ø 20,5 cm / 8,1 in



2,5 cm / 1 in

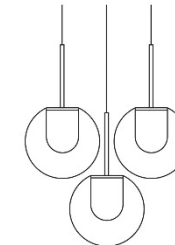

Ø 25 cm / 9,8 in

# DEW CHANDELIER

EMMANUEL BABLED / 2009

MODEL T . MOTUS . KOOI . SLING . KATE . FLOW . MITOS . POISE . DALA . JER . BOLHA . TYLA . FLOED . NAMI . VICEVERSA . GIASS . EVITA . E.T.A . SHAKTI . TATU . LANNÀ . HIVE . LILLI . OPYO .  
DEW . MINIMAL . YUMA . KUSHI . KYUDO . AZOU

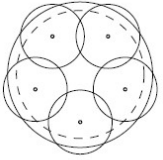

ø 25 cm  
ø 9.8 in

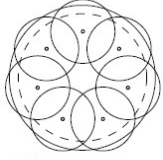

ø 25 cm  
ø 9.8 in

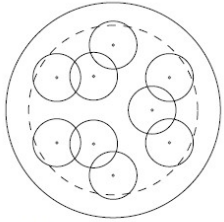

ø 49.5 cm  
ø 19.5 in

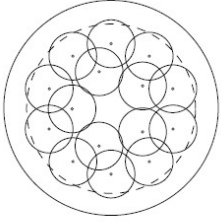

ø 49.5 cm  
ø 19.5 in

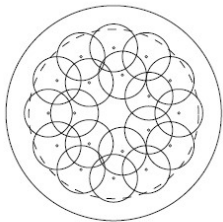

ø 49.5 cm  
ø 19.5 in

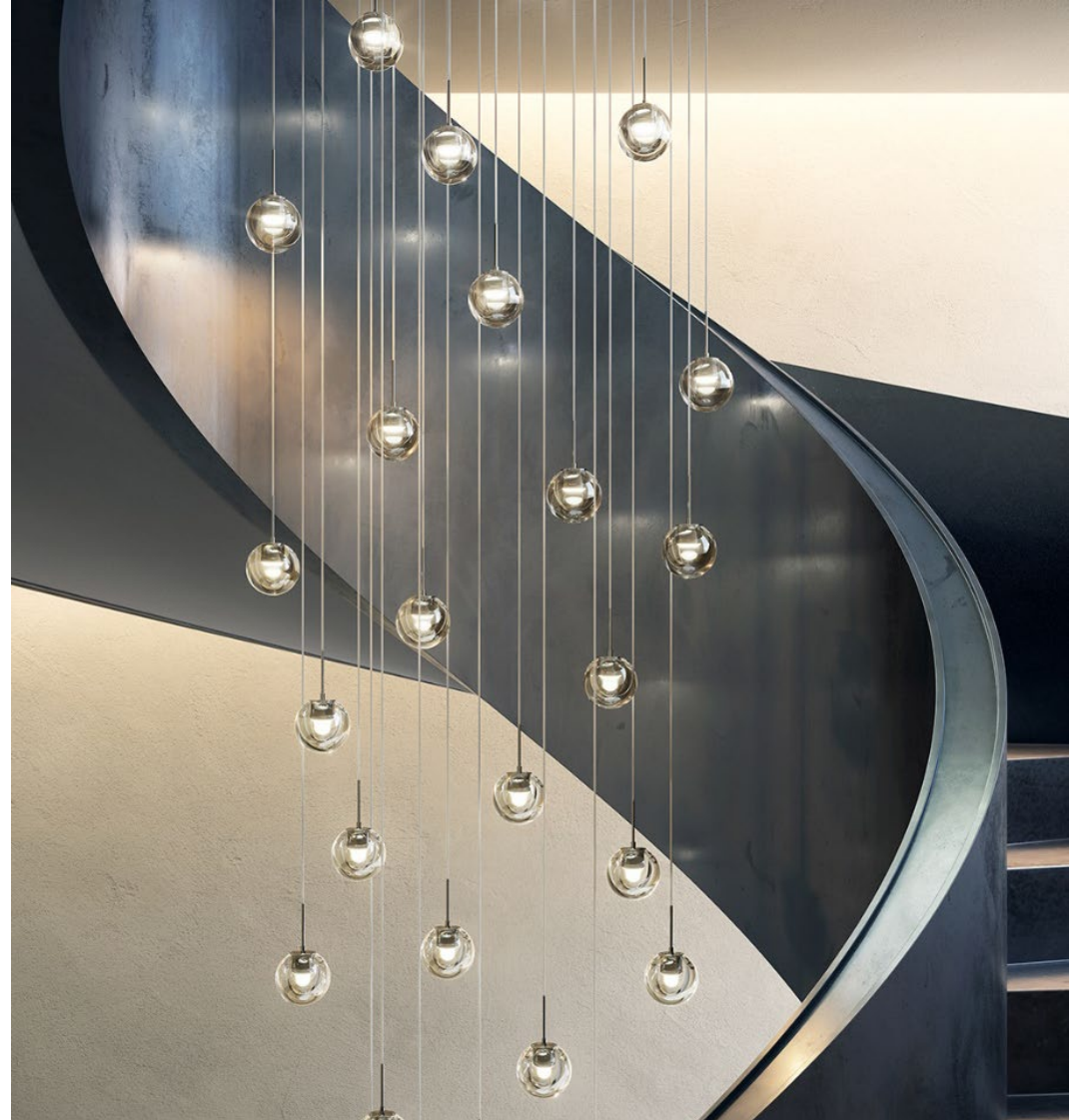



# MINIMAL

DAVID POMPA/ 2017

MODEL T . MOTUS . KOOI . SLING . KATE . FLOW . MITOS . POISE . DALA . JER . BOLHA . TYLA . FLOED . NAMI . VICEVERSA . GIASS . EVITA . E.T.A . SHAKTI . TATU . LANNÀ . HIVE . LILLI . OPYO . DEW . MINIMAL . YUMA . KUSHI . KYUDO . AZOU



## MINIMAL

board LED 1x3.15W  
2700 K - 410 lm - CRI>80

DC 350mA constant current

Dimmable

The encounter between a young designer and the artisan culture of his birthplace. The minimal lines reveal the beauty of Barro Negro pottery created with age-old techniques. The polished black colour obtained with a special firing, together with the minor imperfections of manual craftsmanship, create an eye-catching contrast with the metal part.

Suspension lamp with handcrafted pottery body and metal structure.

Cable length: 180 cm / 70,9 in

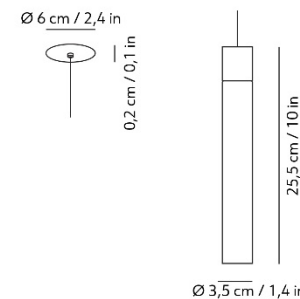

**kdl**n

### LIST PRICE

MINIMAL: \$ 560

DRIVER (ON REQUEST): \$ 70

CANOPY (ON REQUEST): \$ 160

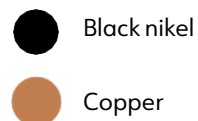



# YUMA

DAVID POMPA / 2017

MODEL T . MOTUS . KOOI . SLING . KATE . FLOW . MITOS . POISE . DALA . JER . BOLHA . TYLA . FLOED . NAMI . VICEVERSA . GIASS . EVITA . E.T.A . SHAKTI . TATU . LANNÀ . HIVE . LILLI . OPYO . DEW . MINIMAL . YUMA . KUSHI . KYUDO . AZOU



## YUMA

1x20W max - E27 (E26)

120V

Dimmable

ETL CANADA + USA

The Yuma desert stretches between the USA and northern Mexico and is revived in the design culture of the designer, David Pompa. The polished brass body of the lamp constantly reflects and changes everything around it, conjuring up the dunes that disappear into infinity, never alike. The magic of oases and mirages returns in the refraction of the rough, textured glass.

Suspension lamp with spun metal reflector and blown glass diffuser.

Cable length: 180 cm / 70,9 in

### LIST PRICE

\$ 790



Brass

Ø 12,5 cm / 4,9 in



3 cm / 1,2 in

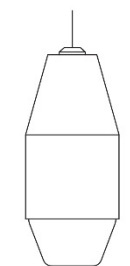

25,5 cm / 10 in

Ø 11 cm / 4,3 in

# KUSHI SUSPENSION

A.SAGGIA & V.SOMMELLA / 2015

MODEL T . MOTUS . KOOI . SLING . KATE . FLOW . MITOS . POISE . DALA . JER . BOLHA . TYLA . FLOED . NAMI . VICEVERSA . GIASS . EVITA . E.T.A . SHAKTI . TATU . LANNÀ . HIVE . LILLI . OPYO . DEW . MINIMAL . YUMA . KUSHI . KYUDO . AZOU



**KUSHI 16 SUSPENSION**  
1x25W max - G9

**KUSHI 33 SUSPENSION**  
1x30W max - E27 (E26)

**KUSHI XL SUSPENSION**  
2x70W max - E27 (E26)

120V

Dimmable

ETL USA

**Kushi, "skewer" in Japanese. An abstract shape freely inspired by Japanese cuisine. A gently rounded glass shape pierced by a thin metal rod. Its soft, warm light floats gently in the space. In the suspended version, it is an elegant invitation for dining in contract spaces and at home.**

Suspension lamp. Opal diffuser made of blown glass.  
Metallic Body available in three coating finishes: black, copper and brass.  
Cable length: 180 cm / 70,9 in

#### LIST PRICE

KUSHI 16 SUSP. \$ 650

KUSHI 33 SUSP. \$ 980

KUSHI XL SUSP. \$ 1690

● Black

● Brass

● Copper

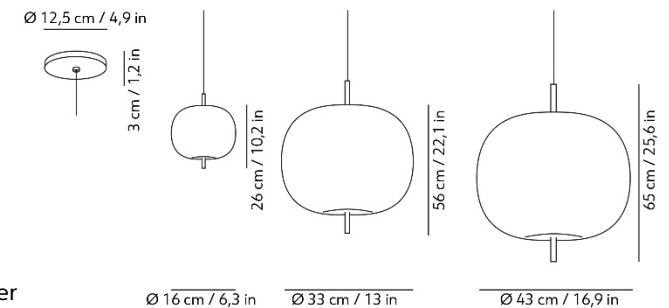

# KUSHI XL FLOOR

A.SAGGIA & V.SOMMELLA / 2019

MODEL T . MOTUS . KOOI . SLING . KATE . FLOW . MITOS . POISE . DALA . JER . BOLHA . TYLA . FLOED . NAMI . VICEVERSA . GIASS . EVITA . E.T.A . SHAKTI . TATU . LANNÀ . HIVE . LILLI . OPYO . DEW . MINIMAL . YUMA . KUSHI . KYUDO . AZOU



## KUSHI XL FLOOR

2x70W max - E27 (E26)

Ø 6 cm max

120V

Dimmer included

ETL USA

**A long, metal rod pierces the soft glass diffuser. The evocative intensity of the simplest and purest of shapes for an imposing lamp with a sophisticated and discrete presence.**

Dimmable floor lamp. Opal diffuser made of blown glass. Metallic body available in three coating finishes: black, copper and brass.

**kdl**<sup>ni</sup>

LIST PRICE

\$ 2690



Black



Brass



Copper



# KUSHI FLOOR

A.SAGGIA & V.SOMMELLA / 2016

MODEL T . MOTUS . KOOI . SLING . KATE . FLOW . MITOS . POISE . DALA . JER . BOLHA . TYLA . FLOED . NAMI . VICEVERSA . GIASS . EVITA . E.T.A . SHAKTI . TATU . LANNÀ . HIVE . LILLI . OPYO . DEW . MINIMAL . YUMA . KUSHI . KYUDO . AZOU



## KUSHI FLOOR

board LED 3x4.6W  
2700 K - 1900 lm - CRI > 80

120 V

Dimmer included

**Travel, explore and get inspired. Kushi, the traditional Japanese skewer, becomes an original floor lamp. Three slim rods and three glass diffusers are intertwined. Elegant, welcoming atmospheres for the contract world and home interiors.**

Dimmable floor lamp. Opal diffuser made of blown glass. Metallic body available in three coating finishes: black, copper and brass.

**kdl**n

LIST PRICE

\$ 2290



Black



Brass



Copper

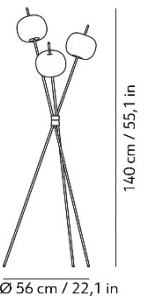



# KUSHI TABLE

A.SAGGIA & V.SOMMELLA / 2015

MODEL T . MOTUS . KOOI . SLING . KATE . FLOW . MITOS . POISE . DALA . JER . BOLHA . TYLA . FLOED . NAMI . VICEVERSA . GIASS . EVITA . E.T.A . SHAKTI . TATU . LANNÀ . HIVE . LILLI . OPYO . DEW . MINIMAL . YUMA . KUSHI . KYUDO . AZOU



**KUSHI 16 TABLE**  
1x25W max - G9

**KUSHI 33 TABLE**  
1x30W max - E27 (E26)

120 V

ETL CANADA + USA

**The round shape of the soft-feel glass diffuser. The strength of the metal rod which runs through it. A new balance for a statement lamp. Even in the portable version, to take with you wherever you go, from the living room to the terrace, study or bedroom.**

Table lamp. Opal diffuser made of blown glass. Metallic body available in four coating finishes: black, copper, brass and wood.

## LIST PRICE

KUSHI 16 TABLE: \$ 625

KUSHI 33 TABLE: \$ 990



Black



Brass



Copper

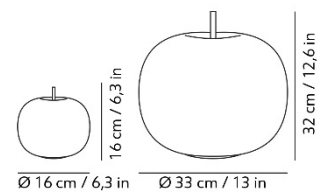



# KUSHI XL TABLE

A.SAGGIA & V.SOMMELLA / 2019

MODEL T . MOTUS . KOOI . SLING . KATE . FLOW . MITOS . POISE . DALA . JER . BOLHA . TYLA . FLOED . NAMI . VICEVERSA . GIASS . EVITA . E.T.A . SHAKTI . TATU . LANNÀ . HIVE . LILLI . OPYO . DEW . MINIMAL . YUMA . KUSHI . KYUDO . AZOU



**KUSHI XL TABLE**  
1x70W max - E27 (E26)

Dimmer included

120 V

ETL USA

**A perfectly balanced contrast in shapes and materials. The clear-cut, understated metal rod pierces the soft glass diffuser. Kushi, in the XL version, amplifies the sensation of balance and purity.**

Dimmable table lamp. Opal diffuser made of blown glass. metallic body available in three coating finishes: black, copper and brass.

**LIST PRICE**  
\$ 1450

 Black

 Brass

 Copper

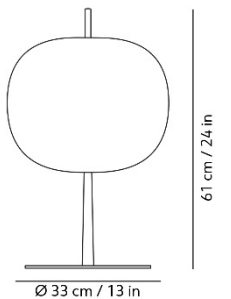

# KUSHI MOBILE

A.SAGGIA & V.SOMMELLA / 2017

MODEL T . MOTUS . KOOI . SLING . KATE . FLOW . MITOS . POISE . DALA . JER . BOLHA . TYLA . FLOED . NAMI . VICEVERSA . GIASS . EVITA . E.T.A . SHAKTI . TATU . LANNÀ . HIVE . LILLI . OPYO .  
DEW . MINIMAL . YUMA . KUSHI . KYUDO . AZOU



## KUSHI MOBILE

board LED 1x1.3W  
2700 K - 150 lm - CRI>80

Rechargeable battery  
5V min500mA

**The round shape of the soft-feel glass diffuser. The strength of the metal rod which runs through it. A new balance for a statement lamp. Even in the portable version, to take with you wherever you go, from the living room to the terrace, study or bedroom.**

Table lamp with rechargeable battery. Opal diffuser made of blown glass. Metallic body available in four coating finishes: black, copper, brass and wood.

**kdl**n

LIST PRICE

\$ 690



Black



Brass



Copper

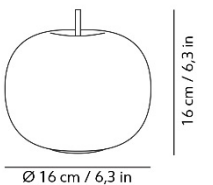

# KUSHI CEILING

A.SAGGIA & V.SOMMELLA / 2015

MODEL T . MOTUS . KOOI . SLING . KATE . FLOW . MITOS . POISE . DALA . JER . BOLHA . TYLA . FLOED . NAMI . VICEVERSA . GIASS . EVITA . E.T.A . SHAKTI . TATU . LANNÀ . HIVE . LILLI . OPYO . DEW . MINIMAL . YUMA . KUSHI . KYUDO . AZOU



**KUSHI 33 CEILING**  
1x30W max - E27 (E26)

**KUSHI XL CEILING**  
2x70W max - E27 (E26)

Dimmable

120 V

ETL CANADA + USA

**A play on opposites, unexpected equilibrium. Soft, natural curves for the glass diffuser and a simple metal line which passes through and completes it. A convergence of shapes which rest gently on walls and ceilings producing a soft, warm light. When the beauty of design stems from the quest for simplicity.**

Ceiling lamp. Opal diffuser made of blown glass. Metallic body available in three coating finishes: black, copper and brass.

## LIST PRICE

KUSHI 33 CEILING: \$ 950

KUSHI XL CEILING: \$ 1350



Black



Brass



Copper

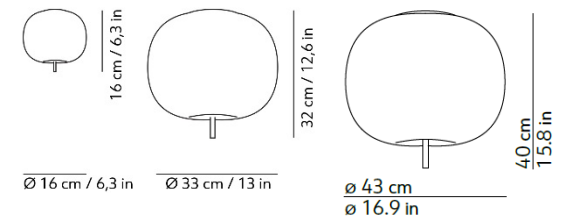

# KYUDO

HANSANDFRANZ

MODEL T . MOTUS . KOOI . SLING . KATE . FLOW . MITOS . POISE . DALA . JER . BOLHA . TYLA . FLOED . NAMI . VICEVERSA . GIASS . EVITA . E.T.A . SHAKTI . TATU . LANNÀ . HIVE . LILLI . OPYO . DEW . MINIMAL . YUMA . KUSHI . KYUDO . AZOU

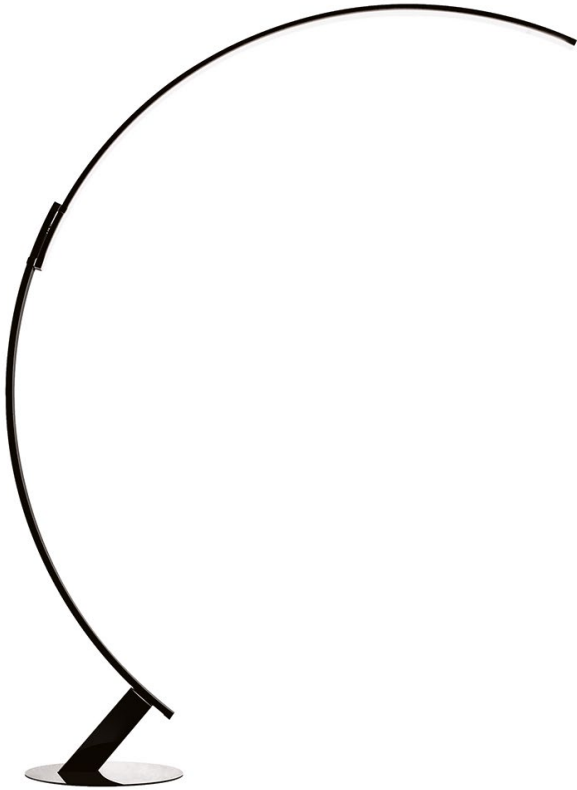

**KYUDO**  
strip LED 1x43.2W  
2700 K - 4200 lm - CRI > 90

100-240 V

Dimmer included

**Kyudo literally means the “way of the bow”, a thousand-year-old discipline inspired by Zen philosophy. And like an arc of light, the floor lamp conveys a sense of balance and elegance. The continuous sequence of LED lights creates an adjustable ribbon of light thanks to the two arcs that form the structure and slide one over the other.**

Floor lamp with diffuser mounted on adjustable sliding track. Extruded aluminium body with glossy varnish coating. Low voltage Led strip.

**kdl**n

**LIST PRICE**  
\$ 3850

White

Black

Orange

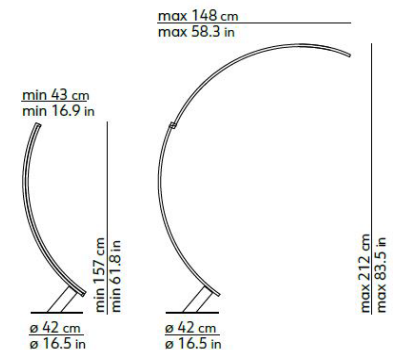

# AZOU 3

CHRIS BASIAS / 2019

MODEL T . MOTUS . KOOI . SLING . KATE . FLOW . MITOS . POISE . DALA . JER . BOLHA . TYLA . FLOED . NAMI . VICEVERSA . GIASS . EVITA . E.T.A . SHAKTI . TATU . LANNÀ . HIVE . LILLI . OPYO . DEW . MINIMAL . YUMA . KUSHI . KYUDO . AZOU

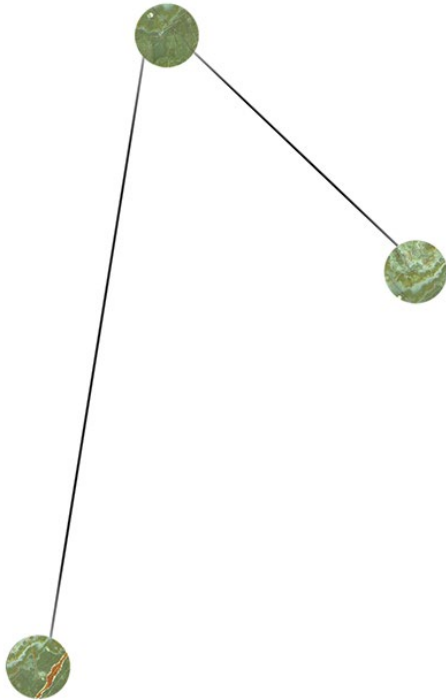

Each point of light is connected to the next one by a slender thread, tracing unexpected paths. Azou always draws different maps. An infinite number of compositions to make a bold statement and add a touch of poetry to interior design.

Wall lamp with onyx or marble disc and painted metal structure. Available in modules of 3, 5 and 7 light points.

## LIST PRICE

AZOU 3 MARBLE white: \$ 1715

AZOU 3 MARBLE black: \$ 1715

AZOU 3 ONYX: \$ 2715

## OPTIONAL

**Driver + dimmer + plug: \$ 290**

**Black canopy: \$ 205**

**Driver dim. 1-10V or push: \$ 190**

 Green onyx

 Black marble

 White marble

## AZOU 3

board LED 3x4.2W

2700 K - 1350 lm - CRI>90

220-240 / 120 V

Dimmer included

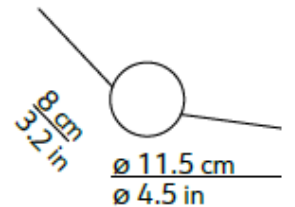

CANOPY

DRIVER+DIMMER+PLUG

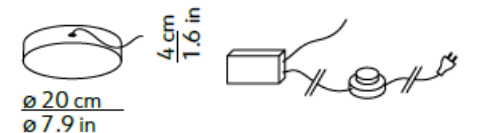



# AZOU 5

CHRIS BASIAS / 2019

MODEL T . MOTUS . KOOI . SLING . KATE . FLOW . MITOS . POISE . DALA . JER . BOLHA . TYLA . FLOED . NAMI . VICEVERSA . GIASS . EVITA . E.T.A . SHAKTI . TATU . LANNÀ . HIVE . LILLI . OPYO . DEW . MINIMAL . YUMA . KUSHI . KYUDO . AZOU

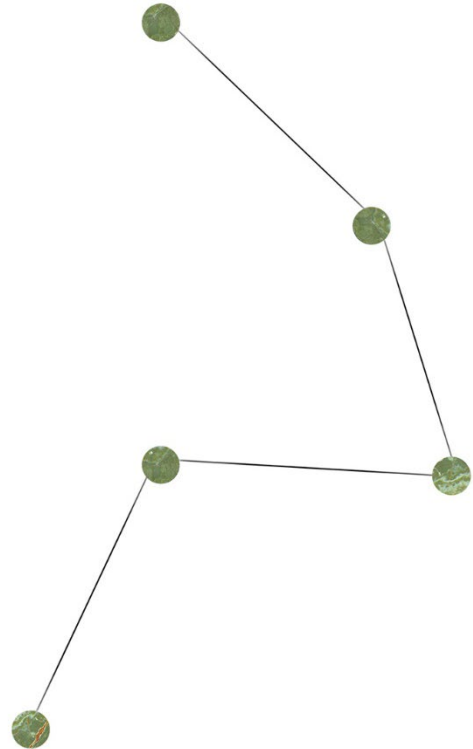

Each point of light is connected to the next one by a slender thread, tracing unexpected paths. Azou always draws different maps. An infinite number of compositions to make a bold statement and add a touch of poetry to interior design.

Wall lamp with onyx or marble disc and painted metal structure. Available in modules of 3, 5 and 7 light points.

## LIST PRICE

AZOU 5 MARBLE white: \$ 2370

AZOU 5 MARBLE black: \$ 2370

AZOU 5 ONYX: \$ 3950

## OPTIONAL

Driver + dimmer + plug: \$ 290

Black canopy: \$ 205

Driver dim. 1-10V or push: \$ 190

 Green onyx

 Black marble

 White marble

## AZOU 5

board LED 5x4.2W

2700 K - 2250 lm - CRI>90

220-240 / 120 V

Dimmer included

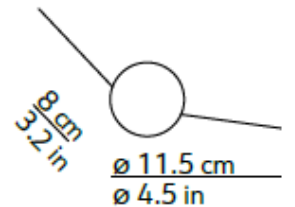

CANOPY

DRIVER+DIMMER+PLUG

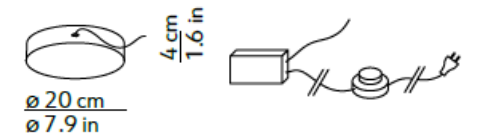

# AZOU 7

CHRIS BASIAS / 2019

MODEL T . MOTUS . KOOI . SLING . KATE . FLOW . MITOS . POISE . DALA . JER . BOLHA . TYLA . FLOED . NAMI . VICEVERSA . GIASS . EVITA . E.T.A . SHAKTI . TATU . LANNÀ . HIVE . LILLI . OPYO . DEW . MINIMAL . YUMA . KUSHI . KYUDO . AZOU

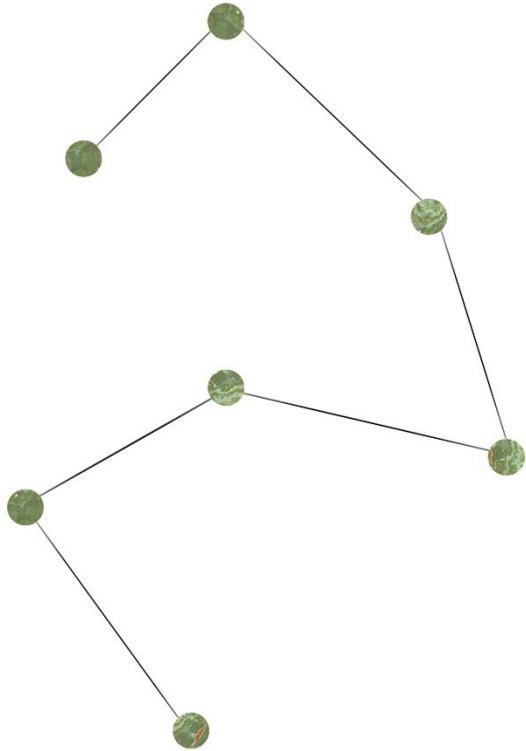

Each point of light is connected to the next one by a slender thread, tracing unexpected paths. Azou always draws different maps. An infinite number of compositions to make a bold statement and add a touch of poetry to interior design.

Wall lamp with onyx or marble disc and painted metal structure. Available in modules of 3, 5 and 7 light points.

## AZOU 7

board LED 7x4.2W  
2700 K - 3150 lm - CRI>90

220-240 / 120 V

Dimmer included

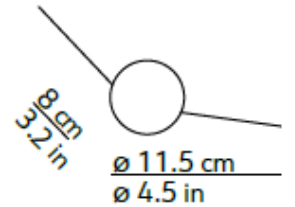

CANOPY

DRIVER+DIMMER+PLUG

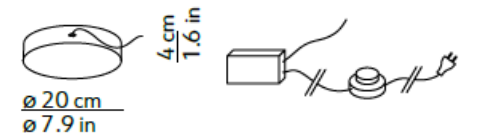

## LIST PRICE

AZOU 7 MARBLE white: \$ 3240

AZOU 7 MARBLE black: \$ 3240

AZOU 7 ONYX: \$ 5640

## OPTIONAL

Driver + dimmer + plug: \$ 290

Black canopy: \$ 205

Driver dim. 1-10V or push: \$ 190

 Green onyx

 Black marble

 White marble

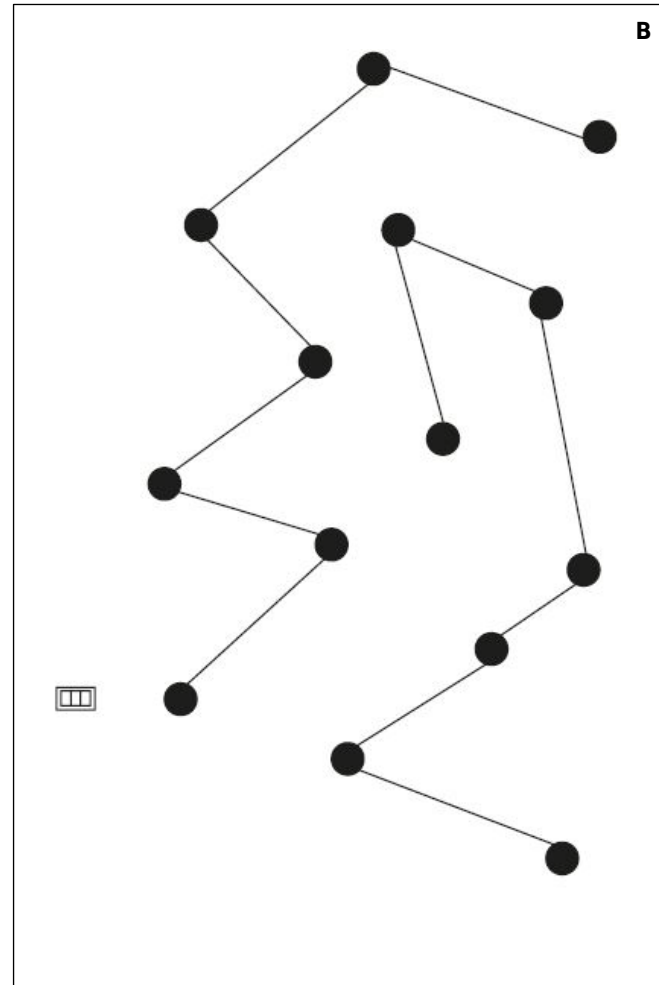
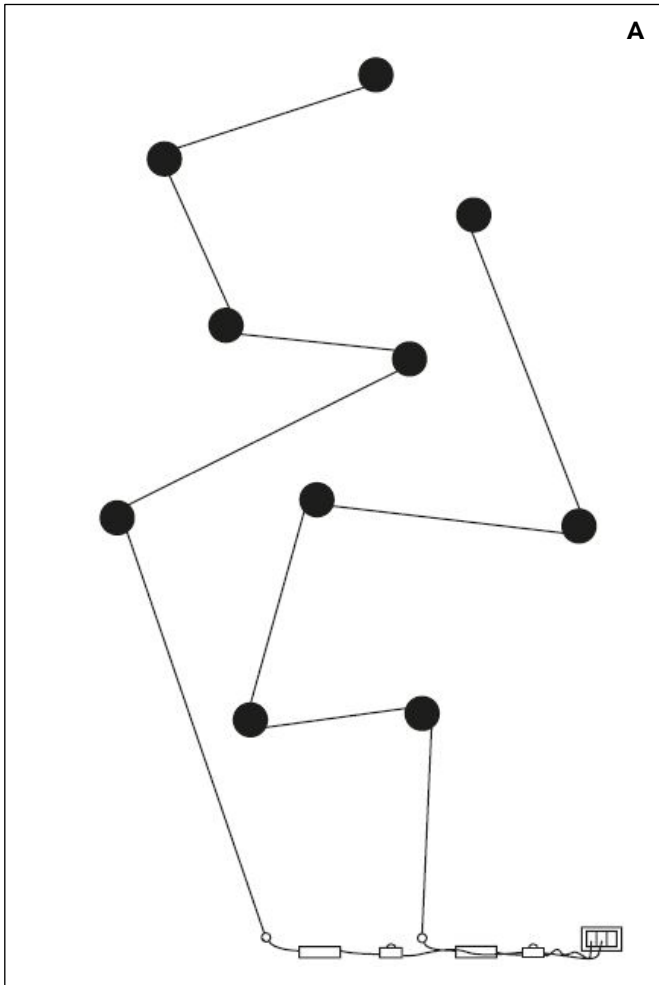

## AZOU MOUNTING TIPS

Azou can't work directly with high voltage, and therefore requires a driver, a dimmer and an outlet (all for external installation, see picture A).

The driver receives a 220V-240V input and provides 700mA output (constant current). Each driver can power a maximum of 7 light bodies.

Composition with more than 7 bodies can be realized by combining two or more Azou, each to be installed with its own driver and outlet. The cable between the last light body of the first Azou and the first light body of the second Azou won't be powered, i.e. its function will be purely aesthetic.

The driver can be hidden inside a ventilated place (picture B) or located in any contiguous environment as long as it's not further than 15 meters. Alternatively, we can provide upon request a driver integrated into a custom made metal canopy that can be fixed on the wall.

